

COIL FORMER

General data 8-pins EE16/8.2 coil former

PARAMETER	SPECIFICATION
Coil former material	phenolformaldehyde (PF), glass-reinforced, flame retardant in accordance with "UL 94V-0"; UL file number E136137
Pin material	copper-tin alloy (CuSn), tin (Sn) plated
Maximum operating temperature	180°C, "IEC 60085", class H
Resistance to soldering heat	"IEC 60068-2-20", Part 2, Test Tb, method 1B, 350 °C, 3.5 s
Soldeerability	"IEC 60068-2-20", Part 2, Test Ta, method 1

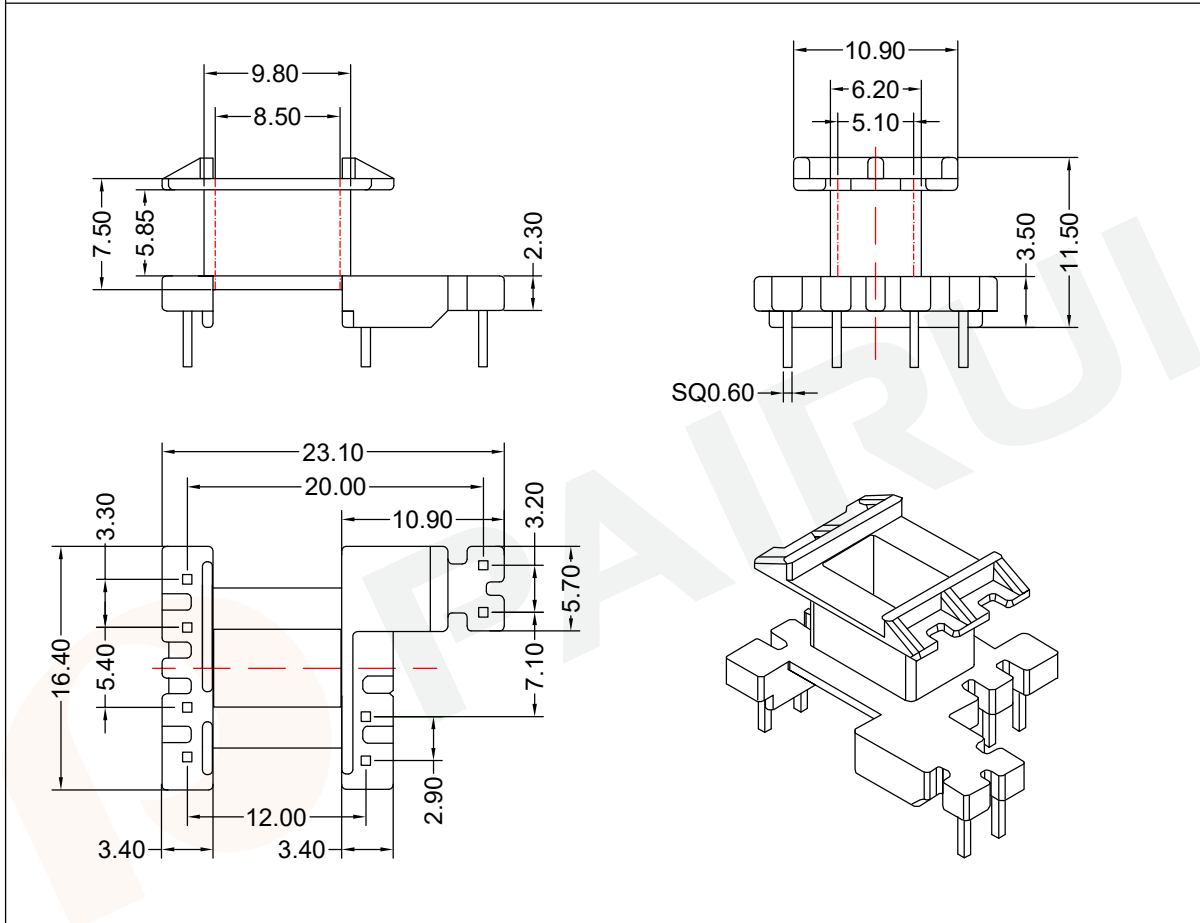

Winding data and area product for 8-pins EE16/8.2 coil former

NUMBER OF SECTIONS	WINDING AREA (mm ²)	MINIMUM WINDING WIDTH (mm)	AVERAGE LENGTH OF TURN (mm)	AREA PRODUCT Ae x Aw (mm ⁴)	TYPE NUMBER
1	14	5.85	43	520	EE-1618-1-1S-8P

Tolerances unless otherwise specified:
 0<L≤4±0.10 4<L≤16±0.20
 16<L≤45±0.30 45≤L±0.40
 Pin Dim:±0.05 Thickness:±0.20 Pin Pitch:±0.20

Dimensions:
(mm)

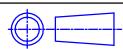

REMARK

Mould No.:	Bobbin material: PF2A5-151J
Code No.: FAY01111	Available for Fuan core: EE16/8.2



Fuan Electronics

TEL :0086-514-87693589
 EML :sales@fuantronics.net
 WEB:www.fuantronics.net

Make: P.Xiao	Material Number: A40160700101
Checked: Beson. zhan	Document/Rev: 00
Approved: Anson. zhan	Date of Recognition: Dec./05/2019