

P3 **T3.94*2.24*2.54** **HP**
Material **Core Size** **Coating**
 材质 品名 涂装

HP:Parylene Coating of Ja;pgem-Free

Ferrite core

Dimensions: (UNIT:mm)

Dimensions(mm)			Wt(g/set)
Parylene Coating Dimensions(mm)			
ΦD1	ΦD2	H	0.10
3.94±0.3	2.24±0.2	2.54±0.2	
3.94±0.3	2.24±0.2	2.54±0.2	

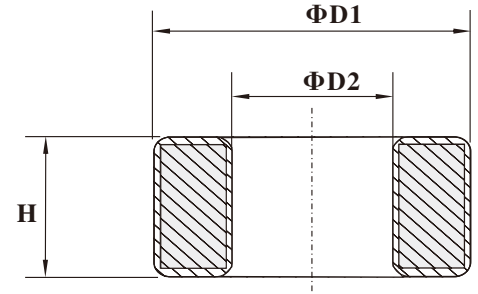
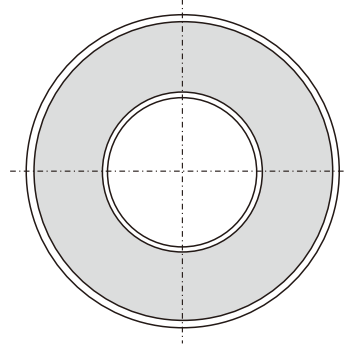

Test Conditions

AL: F=10.0KHz U=0.3V N=10Ts

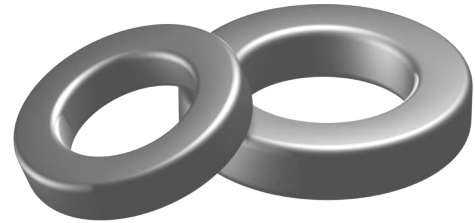

Effective parameter

	Ve(mm ³)	Ae(mm ²)	Le(mm)
	19.353	2.105	9.196

Coating

The core are coated with epoxy, flame retardant in accordance with "UL 94V-0" file number E228348.

The colour is green.

Ring core data

GRADE	AL(nH)	μi	TYPE NUMBER
P3	720±25%	≈2300	T3.94/2.24/2.54/P3
H5K	1438±25%	≈5000	T3.94/2.24/2.54/H5K
H7K	2157±25%	≈7000	T3.94/2.24/2.54/H7K
H10K	2876±30%	≈10000	T3.94/2.24/2.54/H10K

Note:

- 1: Document is the property of FUAN Inc & is not allowed to be duplicated without authorization
- 2: RoHS compliant.

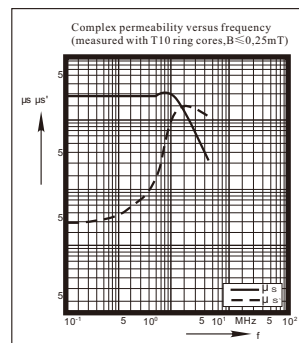

P3

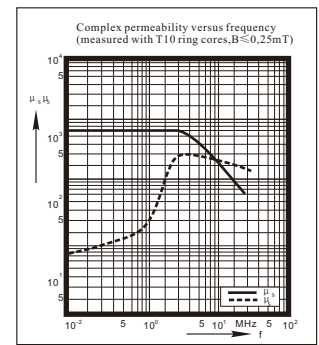

H5K

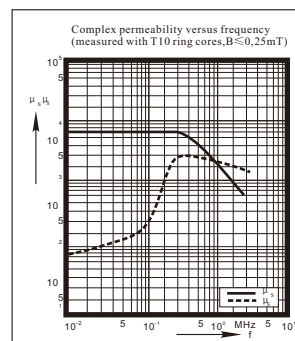

H7K

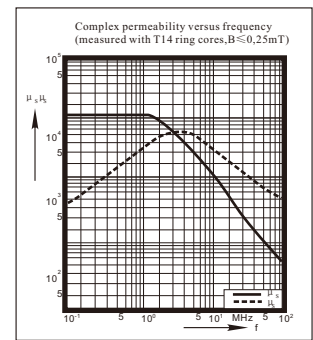

H10K