

OTC-15 EMI FILTER

FAOTC15V series

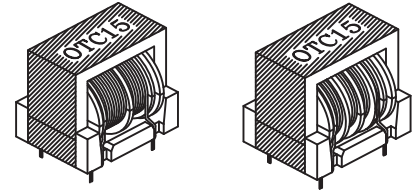

FEATURES

Rated Voltage :85 to 265VAC, 50/60Hz.
 Insulation resistance: 100MΩ Min at 500Vdc.
 Turns ratio: N1:N2=1:1±2%.
 Test Frequency Response: 20KHz/0.1V.
 Withstanding Voltage: 1.5KVAC wind to core, line to line.
 Operating temperature range: -40°C to +105°C.
 All parts meet ROHS compliance.

PRODUCT IDENTIFICATION:

FA OTC 15 V - 2 - 452 Y 0R9
 ① ② ③ ④ ⑤ ⑥ ⑦ ⑧

- ①:Fuan Electronics
- ②:Series name
- ③:Product dimensions
- ④:V is to the vertical form, H is to the horizontal form
- ⑤:Trunking
- ⑥:Inductance Value
- ⑦:Minimum Value
- ⑧:Rated current

ELECTRICAL CHARACTERISTICS

REFERENCE RATING(2 GROOVES BOBBIN)

Part Number	Inductance (L)mH Min	D.C.R. mOHM Max.	Rate Current Amp(ac)REF	Wire DIA.φ (mm)
FAOTC15V-2-452Y0R9	4.5	130	0.90	0.40
FAOTC15V-2-702Y0R8	7.0	200	0.80	0.37
FAOTC15V-2-902Y0R7	9.0	250	0.70	0.35
FAOTC15V-2-113Y0R6	11.0	350	0.60	0.32
FAOTC15V-2-143Y0R5	14.0	430	0.50	0.30
FAOTC15V-2-183Y0R45	18.0	540	0.45	0.28
FAOTC15V-2-303Y0R36	30.0	900	0.36	0.25

REFERENCE RATING(4 GROOVES BOBBIN)

Part Number	Inductance (L)mH Min	D.C.R. mOHM Max.	Rate Current Amp(ac)REF	Wire DIA.φ (mm)
FAOTC15V-4-702Y0R5	7.0	350	0.50	0.30
FAOTC15V-4-902Y0R45	9.0	450	0.45	0.28
FAOTC15V-4-123Y0R36	12.0	600	0.36	0.25
FAOTC15V-4-243Y0R3	24.0	900	0.30	0.23
FAOTC15V-4-403Y0R23	40.0	1500	0.23	0.20
FAOTC15V-4-603Y0R15	60.0	2500	0.15	0.18

Special or custom-made specification is available by request

TECHNICAL INFORMATION

DIMENSION IN mm

2 GROOVES BOBBIN:

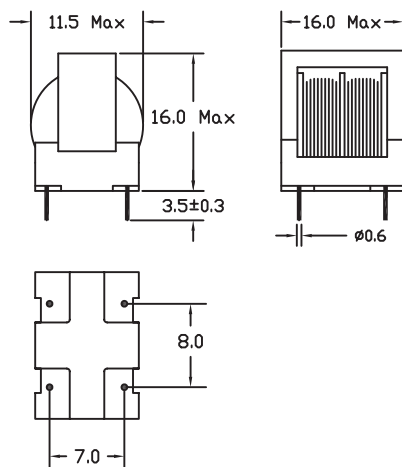

4 GROOVES BOBBIN:

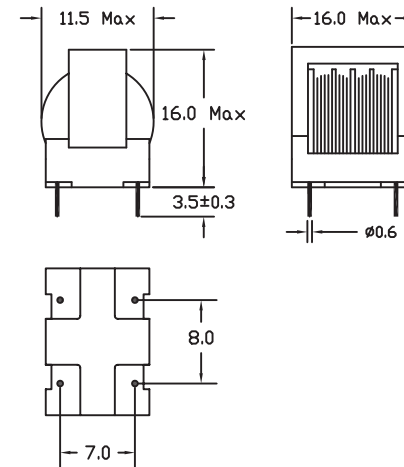

PHYSICAL CHARACTERISTICS

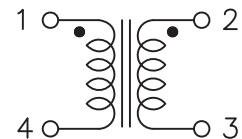

TOLERANCE

- 0 < L < 2 ±0.2
- 2 < L < 12 ±0.4
- 12 < L < 48 ±0.6
- Pin Pitch ±0.5
- Pin Diameter ±0.2