

OTC-25 EMI FILTER

FAOTC25V series

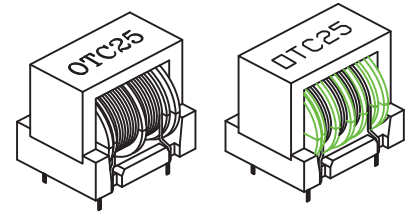

FEATURES

Rated Voltage :85 to 265VAC , 50/60Hz.
 Insulation resistance: 100MΩ Min at 500Vdc.
 Turns ratio: N1:N2=1:1±2%.
 Test Frequency Response: 20KHz/0.1V.
 Withstanding Voltage: 1.5KVAC wind to core, line to line.
 Operating temperature range: -40°C to +105°C.
 All parts meet ROHS compliance.

PRODUCT IDENTIFICATION:

FA OTC 25 V - 2 - 152 Y 5R8
 ① ② ③ ④ ⑤ ⑥ ⑦ ⑧

- ①:Fuan Electronics
- ②:Series name
- ③:Product dimensions
- ④:V is to the vertical form, H is to the horizontal form
- ⑤:Trunking
- ⑥:Inductance Value
- ⑦:Minimum Value
- ⑧:Rated current

ELECTRICAL CHARACTERISTICS

REFERENCE RATING(2 GROOVES BOBBIN)

Part Number	Inductance (L)mH Min	D.C.R. mOHM Max.	Rate Current Amp(ac)REF	Wire DIA.φ (mm)
FAOTC25V-2-302Y5R8	3.0	40	5.8	1.00
FAOTC25V-2-552Y4R7	5.5	60	4.7	0.90
FAOTC25V-2-652Y4R2	6.5	75	4.2	0.85
FAOTC25V-2-902Y3R7	9.0	100	3.7	0.80
FAOTC25V-2-113Y3R3	11.0	120	3.3	0.75

REFERENCE RATING(4 GROOVES BOBBIN)

Part Number	Inductance (L)mH Min	D.C.R. mOHM Max.	Rate Current Amp(ac)REF	Wire DIA.φ (mm)
FAOTC25V-4-402Y3R7	4.0	85	3.7	0.80
FAOTC25V-4-552Y3R3	5.5	100	3.3	0.75
FAOTC25V-4-702Y2R8	7.0	115	2.8	0.70
FAOTC25V-4-113Y2R4	11.0	140	2.4	0.65
FAOTC25V-4-153Y2R1	15.0	200	2.1	0.60

Special or custom-made specification is available by request

TECHNICAL INFORMATION

DIMENSION IN mm

2 GROOVES BOBBIN:

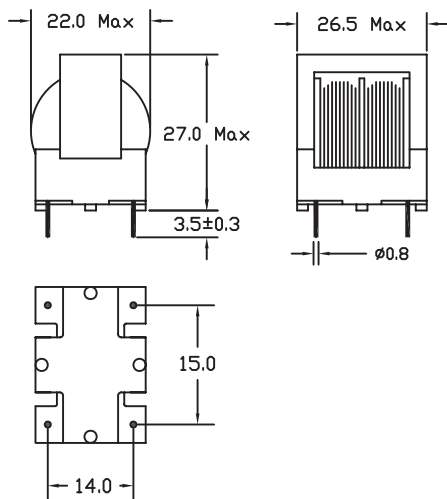

4 GROOVES BOBBIN:

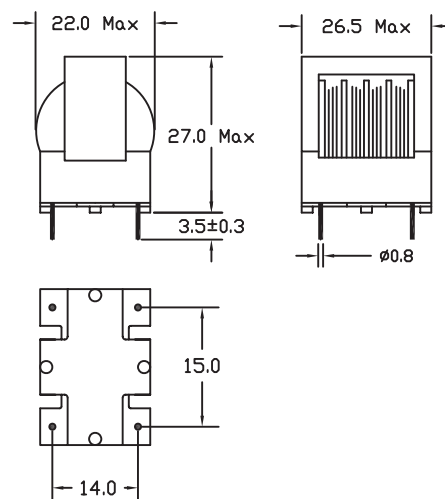

PHYSICAL CHARACTERISTICS

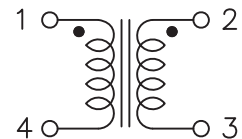

TOLERANCE

0 < L < 2	±0.2
2 < L < 12	±0.4
12 < L < 48	±0.6
Pin Pitch	±0.5
Pin Diameter	±0.2