

P/N: FACM35V-472Y4R0

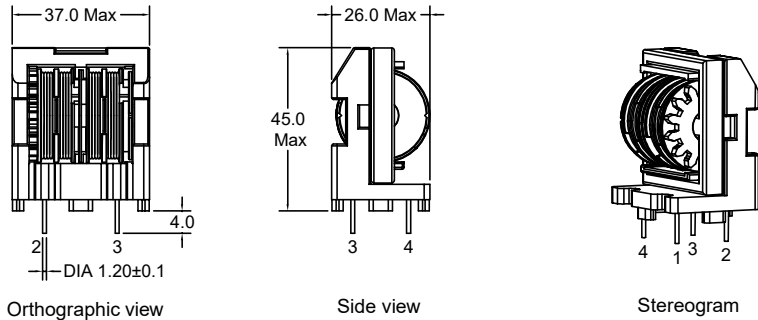

Outline Dimensions (Unit:mm)



Orthographic view

Side view

Stereogram

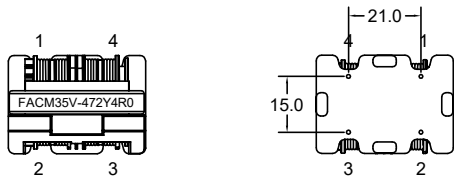

Top view

Bottom view

REMARK:

1. Product vacuum impregnation.

Electrical Schematic

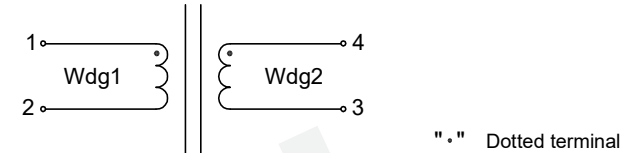

Wave Soldering

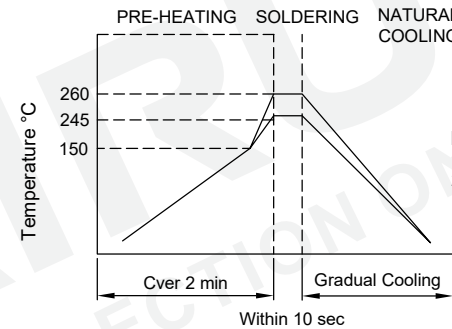

Note:

1. Never Contact the ceramic with the iron tip;
2. 1.0mm tip diameter(max).

Electrical Characteristics

Inductance : L1-2=4-3= 4.7mH Min,at 10KHz,0.1V.

D.C.Resistance : 1-2= 0.060 ohms Max.

4-3= 0.060 ohms Max.

Rated Current : 4.00A

Turns Ratio : Wdg1:Wdg2=1:1±1%,at 20KHz,1V.

Hipot : Coil-Coil : 1500VAC/3mA/2S.

General Properties:

Operating Temperature:-40°C to +105°C
(Temperature rise included).

Storage Temperature:-25°C to +85°C.

Storage Humidity:RH10%~70%.

Weight:≈65.0g.

List of UL Certificate:

No.	Part Name	Mat'l Description	Supplier	UL Number
1	Bobbin	ET35-4S/PBT	Chang Chun Plastics Co Ltd	E59481
2	Base	ET35/T375J	Chang Chun Plastics Co Ltd	E59481
3	Copper wire	2UEW-F/155C	Dong Guan YiDa Industrial Co Ltd	E344055
		2UEW-F/155C	Elektrisola Hangzhou Co Ltd	E258243
4	Core	ET35 TS10	TDG Holding Co Ltd	N/A
		ET35 GH10	Su Zhou Guanda Magnet Co Ltd	N/A
5	Varnish	T-4260(a)/MW80-C	SuZhou TaiHu Electric Advanced Material Co Ltd	E228349

Tianchang Fuan Electronic Co Ltd
www.fuantronics.net
TEL: +86-550-7814888
FAX: +86-550-7831133



Tolerances unless otherwise specified:
(X)±0.50 (XX)±0.25
Unit of measurement: mm

Make: Qiumei.Liu
Checked: Beson. zhan
Approved: Anson. zhan

DRAWING TITLE
ET35V COMMON-CODE
FILTER INDUCTOR
Material Number: A24CM35VS080

Customer P/N:
Document/Rev: 00
Specification Sheet: 1 of 1
Date of Recognition: Mar./13/2020

REV	DESCRIPTION	APPD	DATE