

P3 **T3.05*1.78*1.52** **HP**
Material **Core Size** **Coating**
 材质 品名 涂装

HP:Parylene Coating of Ja;pgem-Free

Dimensions: (UNIT:mm)

Dimensions(mm)			
Parylene Coating Dimensions(mm)			
ΦD1	ΦD2	H	Wt(g/set)
3.05±0.25	1.78±0.2	1.52±0.15	0.05
3.05±0.25	1.78±0.2	1.52±0.15	

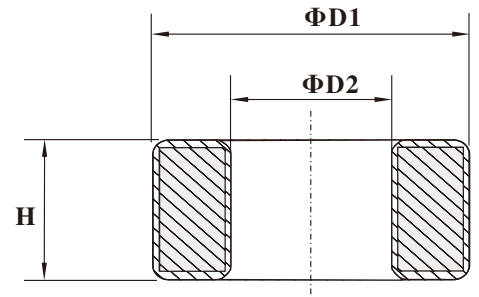
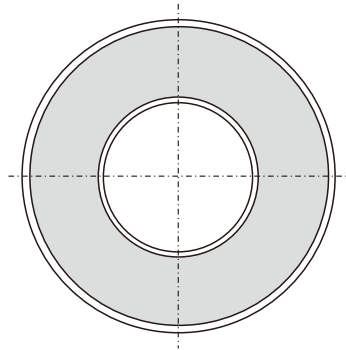

Ferrite core

Test Conditions

AL: F=10.0KHz U=0.3V N=10Ts

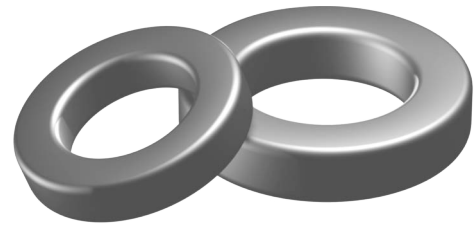

Effective parameter

	Ve(mm3)	Ae(mm2)	Le(mm)
	6.826	0.945	7.226

Coating

The core are coated whth epoxy,
 flame retardant in accordance
 with "UL 94V-0"file number E228348.
 The colour is green.

Ring core data

GRADE	AL(nH)	μi	TYPE NUMBER
P3	420±25%	≈2300	T3.05/1.78/1.52/P3
H5K	821±25%	≈5000	T3.05/1.78/1.52/H5K
H7K	1232±25%	≈7000	T3.05/1.78/1.52/H7K
H10K	1643±30%	≈10000	T3.05/1.78/1.52/H10K

Note:

- 1:Document is the property of FUAN Inc & is not allowed to be duplicated without authorization
- 2:RoHS compliant.

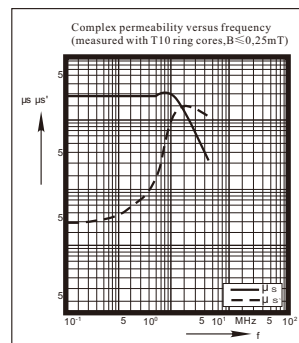

P3

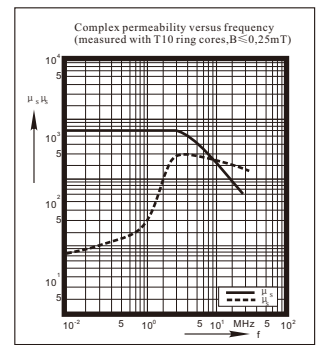

H5K

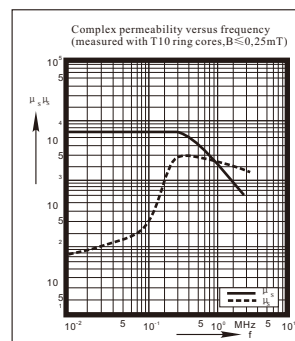

H7K

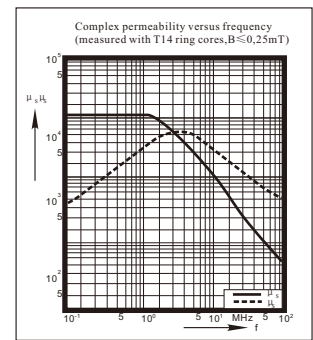

H10K