

**P3**      **T3.5\*1.78\*1.78**      **HP**  
**Material**      **Core Size**      **Coating**  
 材质      品名      涂装

HP:Parylene Coating of Ja;pgem-Free

**Dimensions: (UNIT:mm)**

|                                 |          |          |           |
|---------------------------------|----------|----------|-----------|
| Dimensions(mm)                  |          |          |           |
| Parylene Coating Dimensions(mm) |          |          |           |
| ΦD1                             | ΦD2      | H        | Wt(g/set) |
| 3.5±0.25                        | 1.78±0.2 | 1.78±0.2 | 0.05      |
| 3.5±0.25                        | 1.78±0.2 | 1.78±0.2 |           |

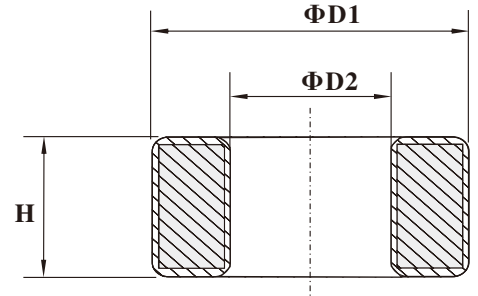
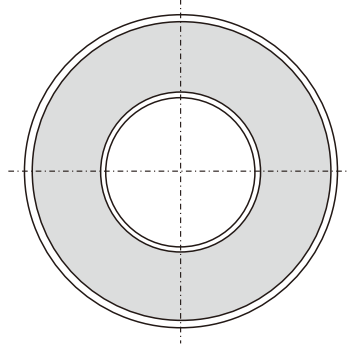

**Ferrite core**

**Test Conditions**

AL: F=10.0KHz    U=0.3V    N=10Ts

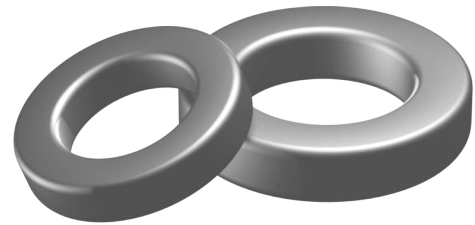

**Effective parameter**

|  |         |         |        |
|--|---------|---------|--------|
|  | Ve(mm3) | Ae(mm2) | Le(mm) |
|  | 10.919  | 1.433   | 7.62   |

**Coating**

The core are coated with epoxy, flame retardant in accordance with "UL 94V-0" file number E228348. The colour is green.

**Ring core data**

| GRADE | AL(nH)   | μi     | TYPE NUMBER         |
|-------|----------|--------|---------------------|
| P3    | 570±25%  | ≈2300  | T3.5/1.78/1.78/P3   |
| H5K   | 1168±25% | ≈5000  | T3.5/1.78/1.78/H5K  |
| H7K   | 1752±25% | ≈7000  | T3.5/1.78/1.78/H7K  |
| H10K  | 2336±30% | ≈10000 | T3.5/1.78/1.78/H10K |

**Note:**

- 1: Document is the property of FUAN Inc & is not allowed to be duplicated without authorization
- 2: RoHS compliant.

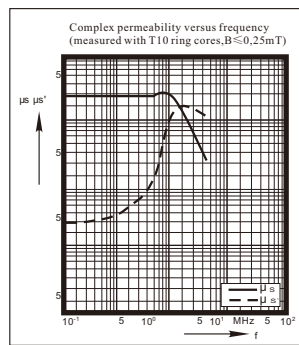

P3

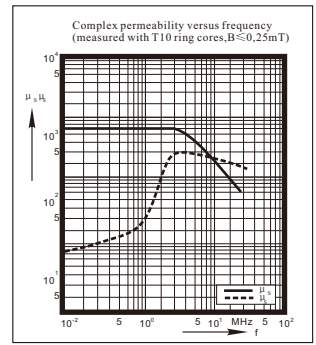

H5K

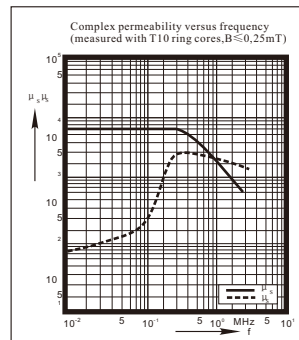

H7K

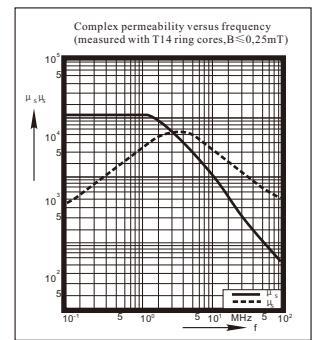

H10K