

P/N: FACCF1515L-303Y1R2-P1

RoHS

Outline Dimensions(Unit:mm)

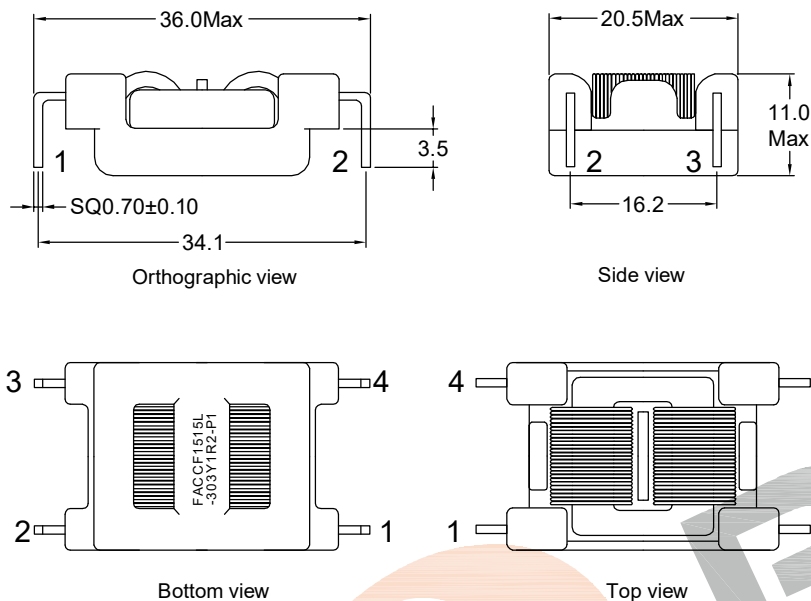

Electronical Schematic

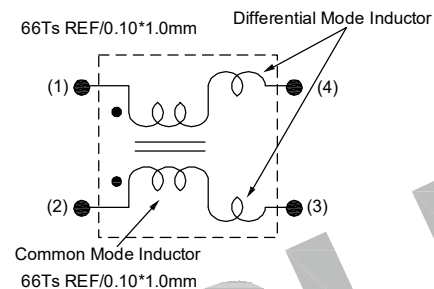

Simulation test curve:

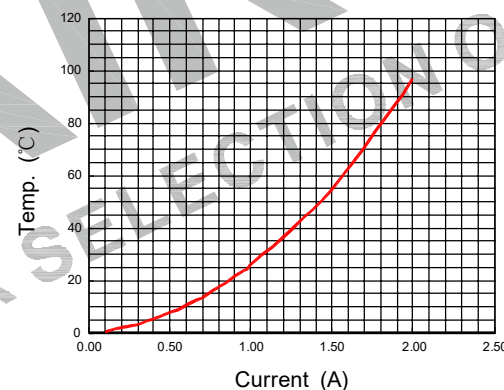

Electrical Characteristics(at 25°C)

Inductance : 30.0mH Min,at 1KHz,0.25V.
 Lstray: Lkg=175uH typ,at 1KHz,0.25V.
 Inductance balance : L1-L2= 400uH Max,at 1KHz,0.25V.
 D.C.Resistance: 340 mohms Max.
 Rated current: 1.2Amps.
 Turns Ratio : 1:1±2%,at 20KHz,1V.
 Hipot : Pri-Sec : 1500VAC/5mA/2Second.

List of UL Certificate:

Part Name	Mat'l Description	Supplier	UL Number
Bobbin	SQ1515/T375HF	Chang Chun Plastics Co Ltd	E59481
Copper wire	SFT-UEW-H	Ningbo Jintian New Material Co Ltd	E227047
Core	SQ1515-H15K	Su Zhou Tian Ming Magnetic	N/A
Epoxy	YZ-HC-1401C	YouZhi Electronic(DongGuan)Co.,Ltd	N/A
or Varnish	T4260LZ	Suzhou Taihu Electric Advanced Material Co., Ltd	E228349

***Weight:Approx 11.3g.

Tianchang Fuan Electronic Co Ltd
 www.fuantronics.net
 TEL: +86-550-7814888
 FAX: +86-550-7831133



Tolerances unless otherwise specified:
 (X)±0.50 (XX)±0.25
 Unit of measurement: mm

Make: Yuing.yu

Checked: Beson. zhan

Approved: Anson. zhan

DRAWING TITLE

CCF1515L Current-compensated
 frame core double chokes

Material Number:

Customer P/N:

Document/Rev: 2207214/00

Specification Sheet: 1 of 1

Date of Recognition: July./16/2022

REV	DESCRIPTION	APPD	DATE