

Outline Dimensions(Unit:mm)

Electronical Schematic:

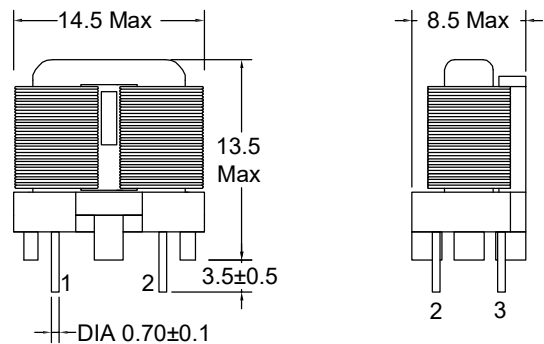

Orthographic view

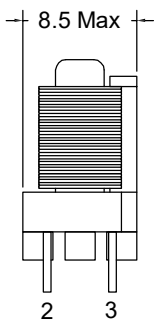

Side view

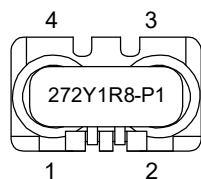

Top view

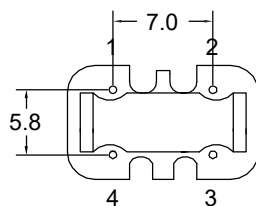

Bottom view

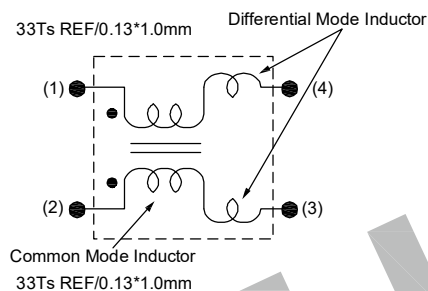

Current VS Temp.(Simulation test).

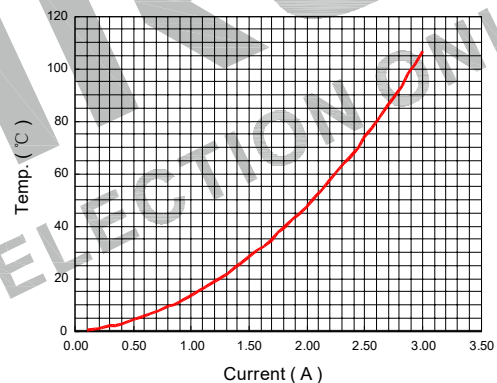

Electrical Characteristics(at 25°C)

Inductance : 2.7mH Min,at 1KHz,0.25V.
 Inductance balance : L1-L2= 100uH Max,at 1KHz,0.25V.
 Lstray: Lkg=32.0uH typ,at 1KHz,0.25V.
 Rated current: 1.8Amps.
 D.C.Resistance : 100 mohms Max.
 Turns Ratio : Wdg1:Wdg2= 1:1±2%,at 20KHz,1V.
 Hipot : Pri-Sec : 1500VAC/1mA/2Second.

List of UL Certificate:

Part Name	Mat'l Description	Supplier	UL Number
Base	SQ10/T375HF	Chang Chun Plastics Co Ltd	E59481
Copper wire	SFT-UEW-H	Ningbo Jintian New Material Co Ltd	E227047
Core	SQ10/10-H10K	ShanDong HengRui Magnet Technology Co Ltd	N/A
Epoxy or Varnish	YZ-HC-1401C	YouZhi Electronic(DongGuan)Co.,Ltd	N/A
	T4260LZ	Suzhou Taihu Electric Advanced Material Co., Ltd	E228349

***Weight:Approx 2.6g.

Tianchang Fuan Electronic Co Ltd
 www.fuantronics.net
 TEL: +86-550-7814888
 FAX: +86-550-7831133

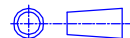

Tolerances unless otherwise specified:
 (.X)±0.50 (.XX)±0.25
 Unit of measurement: mm

Drawn: *Jun*

Checked: *Ben Son*

Approved: *An Son*

DRAWING TITLE
 CCF1010V Current-compensated
 frame core double chokes

Material Number:

Customer P/N:
 Document/Rev: 2207404/00
 Specification Sheet: 1 of 1
 Date of Recognition: July./12/2022

REV	DESCRIPTION	APPD	DATE