

P/N: FALCH1014-330K4R3-□

Outline Dimensions(Unit:mm)

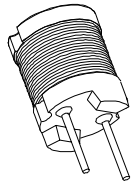
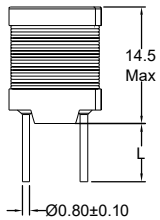

Pins Lead(L):

| | |
|-----|----------|
| -5 | 5.00±1.0 |
| -10 | 10.0±2.0 |
| -15 | 15.0±3.0 |

FALCH1014-330K4R3-5
FALCH1014-330K4R3-10
FALCH1014-330K4R3-15

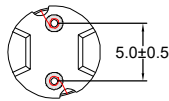

Electronical Schematic

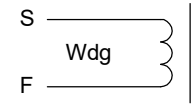

Electrical Characteristics(@25°C)

| Inductance 1KHz,0.3V | DC Resistor | Temp. 40°C | Lldc: 1KHz,0.3V | | |
|-------------------------|-------------|---------------|-----------------|----------|----------|
| | | | 10% drop | 20% drop | 30% drop |
| 33uH±10% | 37mΩ Max | 4300mA | 5000mA | 6000mA | 6700mA |

***Operating Temperature: -40°C~+125°C.
(Temperature rise included)
***Storage Temperature : -40°C~+125°C.
***Storage Humidity:RH10%~70%.

Recommended Soldering Temperature Graph.

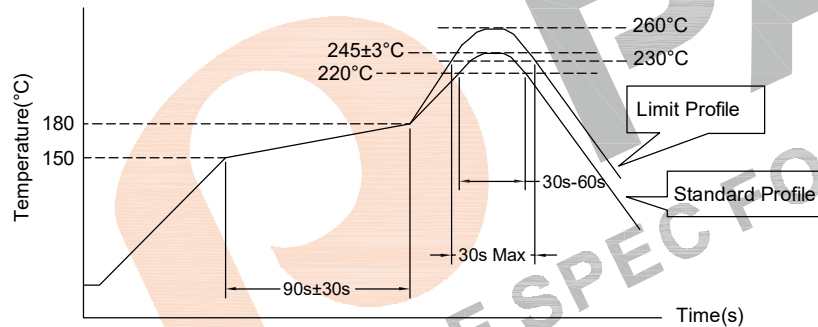

| | Standard Profile | Standard Profile |
|------------------|---------------------|---------------------|
| Pre-heating | 150~180°C,90s±30s | |
| Heating | above 220°C,30s-60s | above 240°C,30s Max |
| Peak temperature | 245°C±3°C | 260°C,10s |
| Cycle of reflow | 2 times | 2 times |

Simulation test curve:

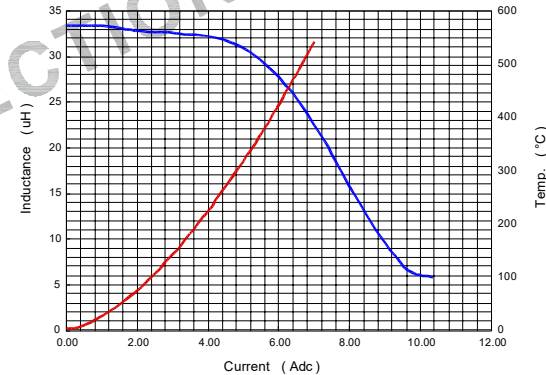

Material list

| Part Name | SPEC | Supplier | UL Number |
|-----------|-------------------------|---------------------------------------|-----------|
| Core | DR2W10*14RF(B=5.4)-NiZn | LiCheng Electronic(ZhangZhou) Co.,Ltd | N/A |
| Wire | 2UEW-F/155°C | ShangDong Saint Electric Co.,Ltd | E194410 |

Tianchang Fuan Electronic Co Ltd
www.fuantronics.net
TEL: +86-550-7814888
FAX: +86-550-7831133

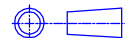

Tolerances unless otherwise specified:
(.X)±0.50 (XX)±0.25
Unit of measurement: mm

Drawn: *June*
Checked: *Benson*
Approved: *AmSon*

DRAWING TITLE
DR2W10*14RF RADIAL FILTER CHOKE
Material Number:

Customer Name:
Document/Rev: 2211222/00
Specification Sheet: 1 of 1
Date of Recognition: Nov./08/2022

| REV | DESCRIPTION | APPD | DATE |
|-----|-------------|------|------|
| | | | |