

P/N: FALCH1014-331K1R35-□

Outline Dimensions(Unit:mm)

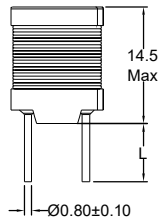

Pins Lead(L):

-5	5.00±1.0
-10	10.0±2.0
-15	15.0±3.0

FALCH1014-331K1R35-5  
 FALCH1014-331K1R35-10  
 FALCH1014-331K1R35-15

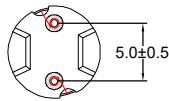
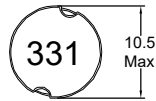

Electronical Schematic

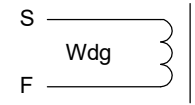

Electrical Characteristics(@25°C)

Inductance 1KHz,0.3V	DC Resistor	Temp. 40°C	Lldc: 1KHz,0.3V		
			10% drop	20% drop	30% drop
330uH±10%	400mΩ Max	1350mA	1700mA	1900mA	2100mA

\*\*\*Operating Temperature: -40°C~+125°C.  
 (Temperature rise included)  
 \*\*\*Storage Temperature : -40°C~+125°C.  
 \*\*\*Storage Humidity:RH10%~70%.

Recommended Soldering Temperature Graph.

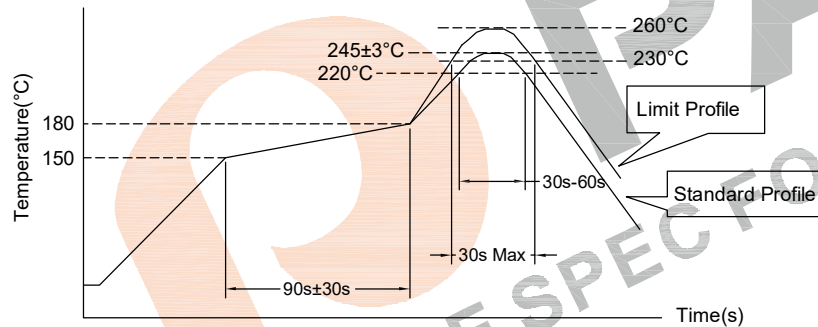

	Standard Profile	Standard Profile
Pre-heating	150~180°C,90s±30s	
Heating	above 220°C,30s-60s	above 240°C,30s Max
Peak temperature	245°C±3°C	260°C,10s
Cycle of reflow	2 times	2 times

Simulation test curve:

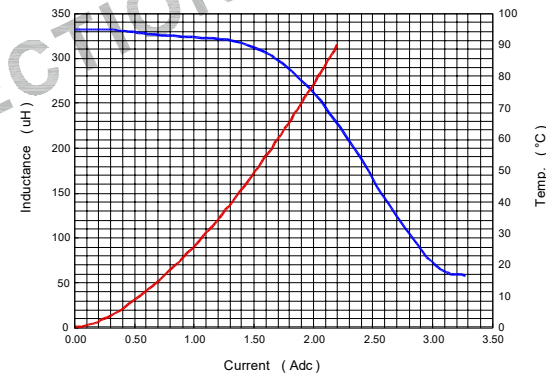

Material list

Part Name	SPEC	Supplier	UL Number
Core	DR2W10*14RF(B=5.4)-NiZn	LiCheng Electronic(ZhangZhou) Co.,Ltd	N/A
Wire	2UEW-F/155°C	ShangDong Saint Electric Co.,Ltd	E194410

Tianchang Fuan Electronic Co Ltd  
 www.fuantronics.net  
 TEL: +86-550-7814888  
 FAX: +86-550-7831133

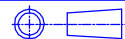

Tolerances unless otherwise specified:  
 (.X)±0.50 (.XX)±0.25  
 Unit of measurement: mm

Drawn: *June*  
 Checked: *Benson*  
 Approved: *AmSon*

**DRAWING TITLE**  
 DR2W10\*14RF RADIAL FILTER CHOKE  
 Material Number:

Customer Name:  
 Document/Rev: 2112015/00  
 Specification Sheet: 1 of 1  
 Date of Recognition: Nov./08/2022

REV	DESCRIPTION	APPD	DATE