

P/N: FALCH1014T-470K3R5-□

Outline Dimensions(Unit:mm)

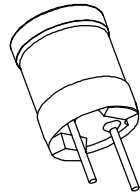
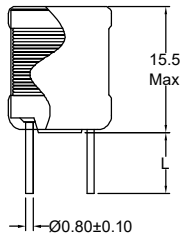

Pins Lead(L):

| | |
|-----|----------|
| -5 | 5.00±1.0 |
| -10 | 10.0±2.0 |
| -15 | 15.0±3.0 |

FALCH1014T-470K3R5-5
 FALCH1014T-470K3R5-10
 FALCH1014T-470K3R5-15

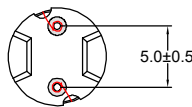

REMARK:

Products need thermal shrinkable sleeve.

Recommended Soldering Temperature Graph.

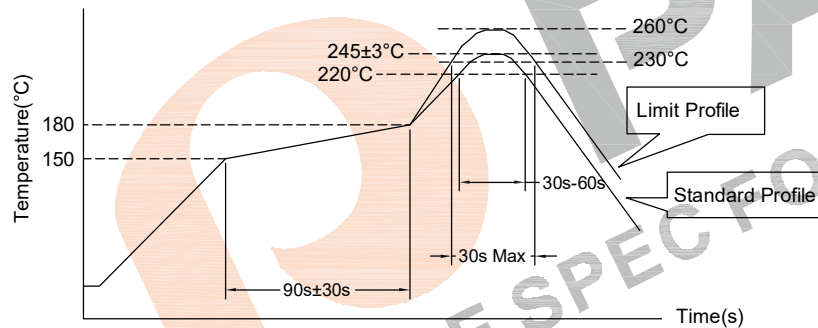

| | Standard Profile | Standard Profile |
|------------------|---------------------|---------------------|
| Pre-heating | 150~180°C,90s±30s | |
| Heating | above 220°C,30s-60s | above 240°C,30s Max |
| Peak temperature | 245°C±3°C | 260°C,10s |
| Cycle of reflow | 2 times | 2 times |

Electronical Schematic

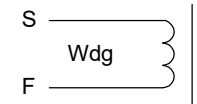

Electrical Characteristics(@25°C)

| Inductance 1KHz,0.3V | DC Resistor | Temp. 40°C | Lldc: 1KHz,0.3V | | |
|-------------------------|-------------|---------------|-----------------|----------|----------|
| | | | 10% drop | 20% drop | 30% drop |
| 47uH±10% | 60mΩ Max | 3500mA | 4500mA | 5200mA | 5700mA |

***Operating Temperature: -40°C~+125°C.
 (Temperature rise included)
 ***Storage Temperature : -40°C~+125°C.
 ***Storage Humidity:RH10%~70%.

Simulation test curve:

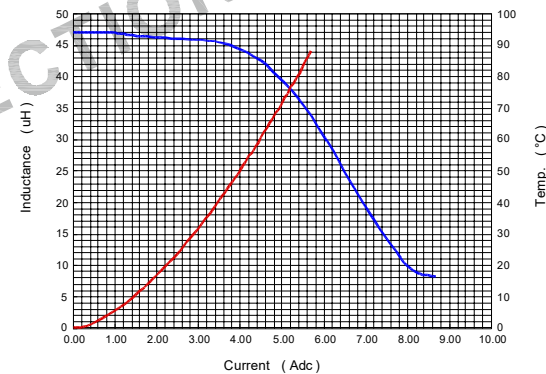

Material list

| Part Name | SPEC | Supplier | UL Number |
|-----------|------------------------------|---|-----------|
| Core | DR2W10*14RF(B=5.4)-NiZn | LiCheng Electronic(ZhangZhou) Co.,Ltd | N/A |
| Wire | 2UEW-F/155°C | ShangDong Saint Electric Co.,Ltd | E194410 |
| Tube | Heat shrinkable casing/125°C | Changyuan Electronics (Shenzhen) Co Ltd | E180908 |

Tianchang Fuan Electronic Co Ltd
 www.fuantronics.net
 TEL: +86-550-7814888
 FAX:+86-550-7831133



Tolerances unless otherwise specified:
 (.X)±0.50 (.XX)±0.25
 Unit of measurement: mm

Drawn: *June*
 Checked: *Benson*
 Approved: *Am Son*

DRAWING TITLE
 DR2W10*14RF RADIAL FILTER CHOKE
 Material Number:

Customer Name:
 Document/Rev: 2211248/00
 Specification Sheet: 1 of 1
 Date of Recognition: Nov./08/2022

| REV | DESCRIPTION | APPD | DATE |
|-----|-------------|------|------|
| | | | |