

P/N: FASDRH1206B-1R0Y10R0

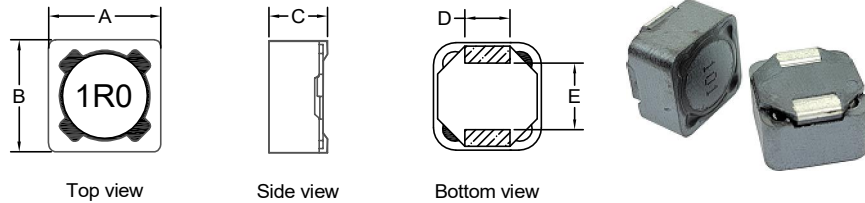

Outline Dimensions(Unit:mm)



| A     | B     | C    | D    | E    |
|-------|-------|------|------|------|
| Max   | Max   | Max  | REF  | REF  |
| 12.80 | 12.80 | 6.50 | 5.00 | 6.00 |

Recommended Soldering Temperature Graph.

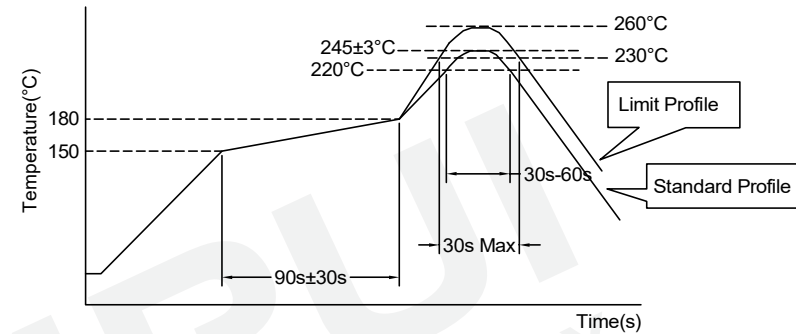

|                  | Standard Profile    | Standard Profile    |
|------------------|---------------------|---------------------|
| Pre-heating      | 150~180°C,90s±30s   |                     |
| Heating          | above 220°C,30s-60s | above 240°C,30s Max |
| Peak temperature | 245°C±3°C           | 260°C,10s           |
| Cycle of reflow  | 2 times             | 2 times             |

Electronical Schematic



Suggested Pad layout

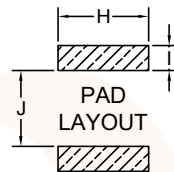

|   |          |
|---|----------|
| H | 5.40 REF |
| I | 2.90 REF |
| J | 5.80 REF |

Electrical Characteristics(@25°C)

| Inductance<br>100KHz,0.1V | DC Resistance | Isat<br>A Max    | Irms<br>(A)△T≤40°C | Q Typ<br>7.96MHz | SRF<br>Typ |
|---------------------------|---------------|------------------|--------------------|------------------|------------|
| 1.00uH±30%                | 7.80mΩ Max    | L(10.0A)≥70%*LOA | 9.40A Max          | 26               | 100MHz     |

General Specifications

- \*Operating Temperature: -40°C~+125°C (Temperature rise included)
- \*Storage Temperature: -40°C~+125°C
- \*Resistance to Soldering Heat: +260°C for 10 Sec
- \*Storage Humidity:RH10%~70%.

Applications

- \*Input/output of DC/DC converters
- \*Power supplies for:
  - Portable communication equipment
  - Camcorders
  - LCD televisions
  - Car radios

|     |             |      |      |   |   |                       |   |                                   |
|-----|-------------|------|------|---|---|-----------------------|---|-----------------------------------|
| REV | DESCRIPTION | APPD | DATE | Tianchang Fuan Electronic Co Ltd<br>www.fuantronics.net<br>TEL: +86-550-7814888<br>FAX: +86-550-7831133 | <br>Tolerances unless otherwise specified:<br>(.X)±0.50 (.XX)±0.25<br>Unit of measurement: mm | Make: Qiumei.Liu      | <b>DRAWING TITLE</b><br>SHIELDED SMD<br>POWER INDUCTORS<br>Material Number: | Customer Name:                    |
|     |             |      |      |   |   | Checked: Beson. zhan  |   | Document/Rev: 2211001/00          |
|     |             |      |      |   |   | Approved: Anson. zhan |   | Specification Sheet: 1 of 4       |
|     |             |      |      |   |   |                       |   | Date of Recognition: Nov./01/2022 |

P/N: FASDRH1206B-1R0Y10R0

RoHS

Packing Specifications(Unit:mm):

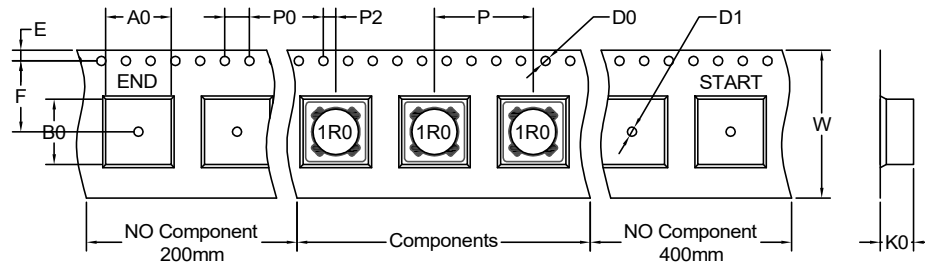

|    |      |    |      |
|----|------|----|------|
| A0 | 12.6 | F  | 11.5 |
| B0 | 12.8 | D0 | 1.50 |
| P  | 16.0 | D1 | 1.50 |
| P0 | 4.00 | K0 | 7.25 |
| P2 | 2.00 | W  | 24.0 |
| E  | 1.75 |    |      |

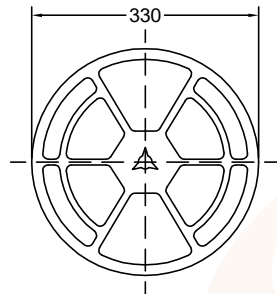

Quantity:600pcs/Reel

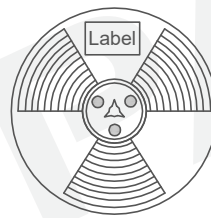
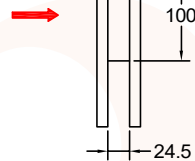

Quantity:600pcs

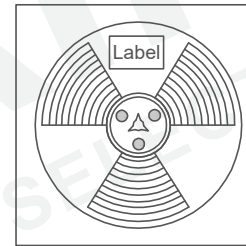

Inner box  
Quantity: 1800 pcs/box

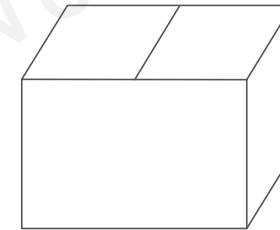

Outer cases: 3600pcs/box  
Insufficient boxes filled with inner boxes or fillers

PAIRUI  
SIMPLE SPEC FOR SELF PROTECTION ONLY

|     |             |      |      |   |   |                             |   |                                   |
|-----|-------------|------|------|---|---|-----------------------------|---|-----------------------------------|
|     |             |      |      | Tianchang Fuan Electronic Co Ltd<br>www.fuantronics.net<br>TEL: +86-550-7814888<br>FAX: +86-550-7831133 | <br>Tolerances unless otherwise specified:<br>(.X)±0.50 (.XX)±0.25<br>Unit of measurement: mm | Make: Qiumei.Liu            | <b>DRAWING TITLE</b><br>SHIELDED SMD<br>POWER INDUCTORS<br>Material Number: | Customer Name:                    |
|     |             |      |      |   |   | Checked: Beson. zhan        |   | Document/Rev: 2211001/00          |
| REV | DESCRIPTION | APPD | DATE |   | Approved: Anson. zhan   | Specification Sheet: 2 of 4 |   | Date of Recognition: Nov./01/2022 |

P/N: FASDRH1206B-1R0Y10R0

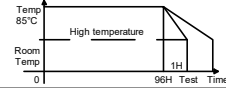
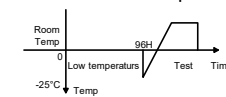
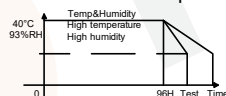
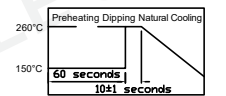

Reliability Testing:

| Ltem  | Specified value   | Test methods  |
|---|---|---|
| High temperature Storage test<br>Reference documents:<br>MIL-STD-202G Method 108A | 1.No case deformation or change in appearance.<br>2. $\Delta L/L \leq 10\%$ .<br>3. $\Delta Q/Q \leq 30\%$ .<br>4. $\Delta DCR/DCR \leq 10\%$ . | Temperature: $85 \pm 2^\circ\text{C}$ Time: $96 \pm 2$ hours.<br><br>Tested not less than 1 hour, not more than 2 hours at room temperature.<br>   |
| Low temperature Storage test.<br>Referencedocuments:<br>IEC 68-2-1A 6.1 6.2       | 1.No case deformation or change in appearance.<br>2. $\Delta L/L \leq 10\%$ .<br>3. $\Delta Q/Q \leq 30\%$ .<br>4. $\Delta DCR/DCR \leq 10\%$ . | Temperature: $25 \pm 2^\circ\text{C}$ Time: $96 \pm 2$ hours.<br><br>Tested not less than 1 hour, not more than 2 hours at room temperature.<br>   |
| Humidity test Reference Documents:<br>MIL-STD-202G Method 103B                    | 1.No case deformation or change in appearance.<br>2. $\Delta L/L \leq 10\%$ .<br>3. $\Delta Q/Q \leq 30\%$ .<br>4. $\Delta DCR/DCR \leq 10\%$ . | 1.Dry oven at a temperature of $40^\circ \pm 5^\circ\text{C}$ for 24 hours.<br>2.Measurements At the end of this period<br>3.Exposure:Temperature: $40 \pm 2^\circ\text{C}$ ,Humidity: $93 \pm 3\% \text{RH}$ Time: $96 \pm 2$ hours.<br>4.Tested while the specimens are still in the chamber.<br>5.Tested not less than 1 hour, nor more than 2 hours at room temperature.<br> |
| Heat endurance of Reflow soldering  | 1.No case deformation or change in appearance.<br>2. $\Delta L/L \leq 10\%$ .<br>3. $\Delta Q/Q \leq 30\%$ .<br>4. $\Delta DCR/DCR \leq 10\%$ . | Preheat: $150^\circ\text{C}$ ,60 second.<br>Solder:Sn/Ag/Cu.<br>Solder:Temperature: $260 \pm 5^\circ\text{C}$ .<br>Flux:Rosin flux.<br>Reflow peak time 10 second at $260^\circ\text{C}$<br>   |

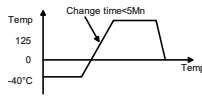
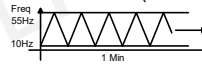
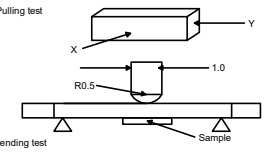
| Ltem   | Specified value   | Test methods   |
|--|---|--|
| Thermal shock test<br>Reference documents:<br>MIL-STD-202G Method 107G                   | 1.No case deformation or change in appearance.<br>2. $\Delta L/L \leq 10\%$ .<br>3. $\Delta Q/Q \leq 30\%$ .<br>4. $\Delta DCR/DCR \leq 10\%$ .<br>For T:weiges $\leq 28\text{g}$ :15 Min<br>28g $\geq$ weights $\leq 136\text{g}$ :30 Min  | First- $40^\circ\text{C}$ for T time,next+ $125^\circ\text{C}$ Ttime as 1 cycle. Go through 20 cycles.<br>    |
| Solderability test<br>Reference documents:<br>MIL-STD-202G Method 208H<br>IPC J-STD-002B | Terminals area must have 95% Min. Solder coverage.  | Dip pads in flux then dip in solder pot at $245 \pm 5^\circ\text{C}$ for 5 second.<br>Soler:Sn(93.5)Ag(3.5).<br>Flux:Rosin flux.   |
| Vibration test<br>Reference documents:<br>MIL-STD-202G Method 201A                       | 1.No case deformation or change in appearance.<br>2. $\Delta L/L \leq 10\%$ .<br>3. $\Delta Q/Q \leq 30\%$ .<br>4. $\Delta DCR/DCR \leq 10\%$ .   | Apply frequency 10~55Hz. 0.75mm amplitude in each of perpendicular direction for 2 hours.(total 6 hours).<br> |
| Drop test<br>Reference documents:<br>MIL-STD-202G Method 203G                            | 1.No case deformation or change in appearance.<br>2. $\Delta L/L \leq 10\%$ .<br>3. $\Delta Q/Q \leq 30\%$ .<br>4. $\Delta DCR/DCR \leq 10\%$ .<br>For T:weiges $\leq 28\text{g}$ :15 Min<br>28g $\geq$ weights $\leq 136\text{g}$ :30 Min  | Packaged & Drop down from 1m with $981\text{m/s}^2$ (100G)attitude in 1 angle 1 ridges & 2 surfaces orientations.  |
| Terminal strength push test<br>Reference documents:<br>JIS C 5321:1997                   | Pulling test:<br>DEFINE:A:sectional area of terminal<br>$A \leq 8(\text{Sq M})$<br>$8(\text{Sq M}) < A \leq 20(\text{Sq M})$<br>Force $\geq 5\text{N}$ time:30sec<br>$8(\text{Sq M}) < A \leq 20(\text{Sq M})$<br>Force $\geq 10\text{N}$ time:10sec<br>$20(\text{Sq M}) < A$ force $\geq 20\text{N}$ time:10sec<br>Bending test:<br>Soldering the products on PCB,after the pulling testand bending test, terminal should not pull off | Bend the testing PCB at middle point, the deflection shall be 2mm<br>                                       |

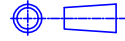
|     |             |      |      |   |  |   |   |  |
|-----|-------------|------|------|---|--|---|---|--|
| REV | DESCRIPTION | APPD | DATE | Tianchang Fuan Electronic Co Ltd<br>www.fuantronics.net<br>TEL: +86-550-7814888<br>FAX: +86-550-7831133 | <br>Tolerances unless otherwise specified:<br>(.X) $\pm 0.50$ (.XX) $\pm 0.25$<br>Unit of measurement: mm | Make: Qiumei.Liu<br>Checked: Beson. zhan<br>Approved: Anson. zhan | <b>DRAWING TITLE</b><br>SHIELDED SMD<br>POWER INDUCTORS<br>Material Number: | Customer Name:<br>Document/Rev: 2211001/00<br>Specification Sheet: 3 of 4<br>Date of Recognition: Nov./01/2022 |
|-----|-------------|------|------|---|--|---|---|--|

P/N: FASDRH1206B-1R0Y10R0



| Ltem   | Specified value   | Test methods   |
|--|---|--|
| Resistance to solvent test<br>Reference documents:<br>IEC 68-2-45:1993 | No case deformation or change in appearance, or obliteration of marking | To dip parts into IPA solvent for 5±0.5Min, then drying them at room temp for 5 Min, at last, to brushing making 10 times. |
| Electronic characteristic test of major products                       | Refer to catalogue of specific products                                 | Refer to catalogue of specific products  |
| Overload test<br>Reference documents:                                  | 1. During the test no smoke, no peculiar, smell, no fire                | Apply twice as rated current for 5 minutes.  |

Recommended solderability temperature profile:

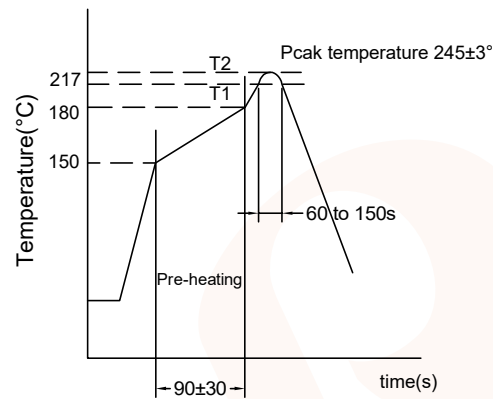

Use rosin-based flux  
Don't use high acidic flux with halide content exceeding 0.2(wt)% (chlorine conversion value).  
Use lead-free solder, use Sn-3.0Ag-0.5Cu solder  
Standard thickness of solder paste: 0.12-0.15mm

|     |             |      |      |   |   |   |   |  |
|-----|-------------|------|------|---|---|---|---|--|
|     |             |      |      | Tianchang Fuan Electronic Co Ltd<br>www.fuantronics.net<br>TEL: +86-550-7814888<br>FAX: +86-550-7831133 | <br>Tolerances unless otherwise specified:<br>(.X)±0.50 (.XX)±0.25<br>Unit of measurement: mm | Make: Qiumei.Liu<br>Checked: Beson. zhan<br>Approved: Anson. zhan | <b>DRAWING TITLE</b><br>SHIELDED SMD<br>POWER INDUCTORS<br>Material Number: | Customer Name:<br>Document/Rev: 2211001/00<br>Specification Sheet: 4 of 4<br>Date of Recognition: Nov./01/2022 |
| REV | DESCRIPTION | APPD | DATE |   |   |   |   |  |